

STEEL BULLET RESISTANT DOOR ORDER SHEET



Customer : _____ Date : _____
 Customer P O: _____ Approved By : _____
 Job : _____ DSM Job No. : _____
 Job Location : _____

111 Merchants Street San Antonio, Texas 78204
 (210) 226-8271 (800) 825-8271 Fax (800) 226-0913

DOOR INFORMATION

Opening Type : Single Pair
 Material : Cold Rolled
 Galvanized
 Stainless Steel
 Primer : Yes No
 Paint : _____
 Standard with S.S. Con't. Hinge
 Hvy. Wt. Butt Hinges (Optional)
 (N) Center Line (A.F.F.)* _____
 Center Line of Hardware Based On :
 Cylinder Lock Mortise Lock
 Panic Strike Mfg Std
 Note : If no choice is selected,
 the center line will be Manufacturers Std.
 * A.A.F. = ABOVE FINISH FLOOR

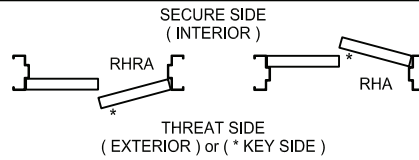
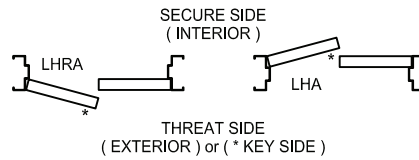
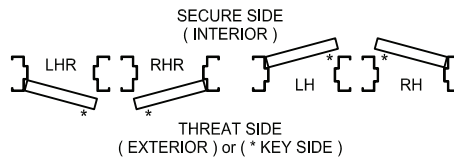

SWING - HANDING

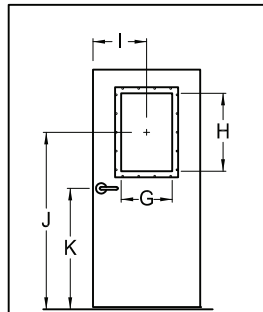
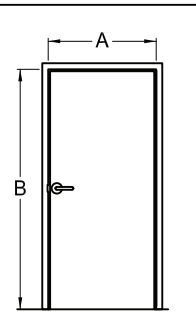

FRAME INFORMATION

WALL TYPE
 Metal Stud Masonry / CMU
 Wood Stud Channel / Tube Steel
 Frame Type : _____
 Frame Anchorage : _____
 (A) Opening Width : _____
 (B) Opening Height : _____
 (C) Wall Thickness : _____
 (D) Jamb Depth : _____
 (E) Jamb face : _____
 (F) Head face : _____
 Rough opening : _____

VISION INFORMATION

No Vision Required
 (G) Vision Width : _____
 (H) Vision Height : _____
 (I) Horizontal CL. : _____
 (J) Vertical CL. : _____
 Glass Provided By : DSM Others

SILL INFORMATION

Sill Condition : _____
 Undercut : _____

UL 752

- Level 1
- Level 2
- Level 3
- Level 4
- Level 5
- Level 6
- Level 7
- Level 8
- n/a
- Shotgun (Lead Slug)
- Shotgun (Buckshot)

NIJ

- II-A *
- II-A *
- III-A *
- n/a
- III
- III-A
- III
- III
- IV

FIRE RATING

U.L. Label :
 3 HR
 1 1/2 HR
 3/4 HR
 20 MIN
 No Label
 UL Procedure :
 UL 10C N/A
 * Fire Rated Glass
 Visions available up
 to 90 minute.

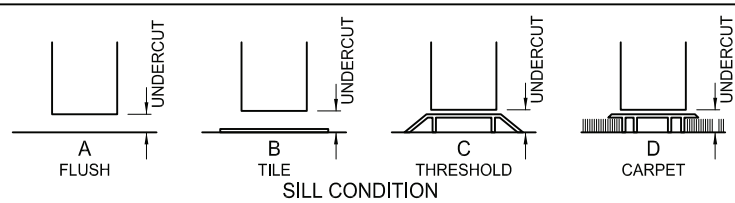

HARDWARE

_____ DSM Others
 _____ DSM Others
 _____ DSM Others
 _____ DSM Others

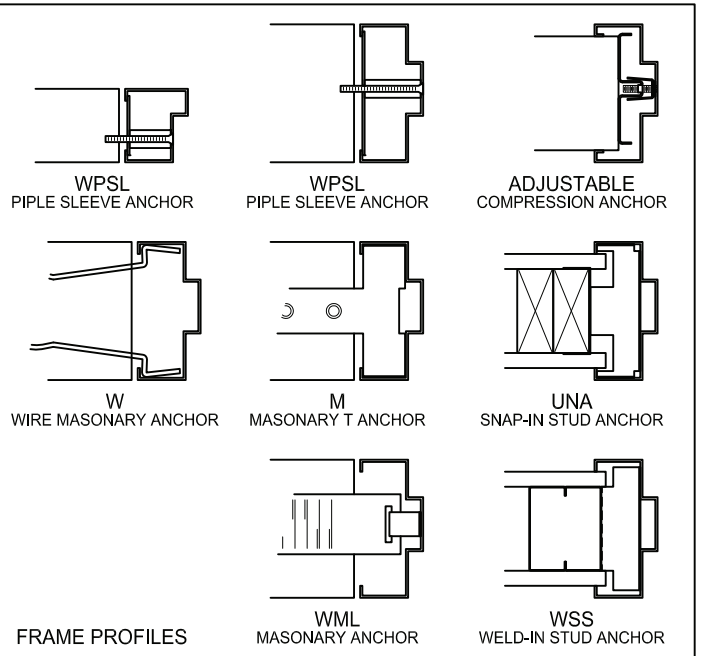
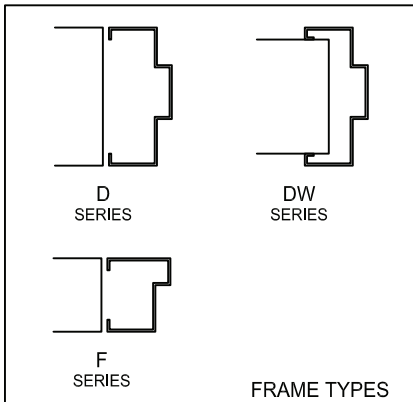
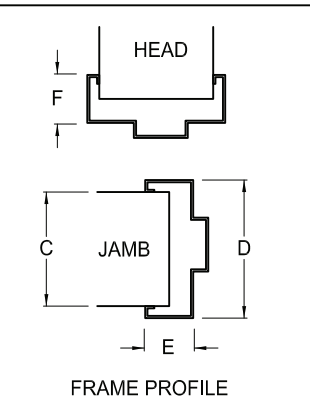

ADDITIONAL INFORMATION
